

***Pioneer***

**DJ MIXER**

# **DJM-600**

**Operating Instructions**

Thank you for buying this Pioneer product. Please read through these operating instructions so you will know how to operate your model properly. After you have finished reading the instructions, put them away in a safe place for future reference.

**WARNING: TO PREVENT FIRE OR SHOCK HAZARD, DO NOT EXPOSE THIS APPLIANCE TO RAIN OR MOISTURE.**

**CAUTION:** This product satisfies FCC regulations when shielded cables and connectors are used to connect the unit to other equipment. To prevent electromagnetic interference with electric appliances such as radios and televisions, use shielded cables and connectors for connections.

**IMPORTANT NOTICE:**  
**RECORD THE MODEL NUMBER AND SERIAL NUMBER OF THIS EQUIPMENT BELOW. THE NUMBERS ARE ON THE REAR PANEL.**

MODEL NO.         DJM-600          
 SERIAL NO.                                 

**KEEP THESE NUMBERS FOR FUTURE USE.**

## SAFETY INSTRUCTIONS

**READ INSTRUCTIONS** — All the safety and operating instructions should be read before the product is operated.

**RETAIN INSTRUCTIONS** — The safety and operating instructions should be retained for future reference.

**HEED WARNINGS** — All warnings on the product and in the operating instructions should be adhered to.

**FOLLOW INSTRUCTIONS** — All operating and use instructions should be followed.

**CLEANING** — Unplug this product from the wall outlet before cleaning. The product should be cleaned only with a polishing cloth or a soft dry cloth. Never clean with furniture wax, benzine, insecticides or other volatile liquids since they may corrode the cabinet.

**ATTACHMENTS** — Do not use attachments not recommended by the product manufacturer as they may cause hazards.

**WATER AND MOISTURE** — Do not use this product near water — for example, near a bathtub, wash bowl, kitchen sink, or laundry tub; in a wet basement; or near a swimming pool; and the like.

**ACCESSORIES** — Do not place this product on an unstable cart, stand, tripod, bracket, or table. The product may fall, causing serious injury to a child or adult, and serious damage to the product. Use only with a cart, stand, tripod, bracket, or table recommended by the manufacturer, or sold with the product. Any mounting of the product should follow the manufacturer's instructions, and should use a mounting accessory recommended by the manufacturer.

**CART** — A product and cart combination should be moved with care. Quick stops, excessive force, and uneven surfaces may cause the product and cart combination to overturn.



**VENTILATION** — Slots and openings in the cabinet are provided for ventilation and to ensure reliable operation of the product and to protect it from overheating, and these openings must not be blocked or covered. The openings should never be blocked by placing the product on a bed, sofa, rug, or other similar surface. This product should not be placed in a built-in installation such as a bookcase or rack unless proper ventilation is provided or the manufacturer's instructions have been adhered to.

**POWER SOURCES** — This product should be operated only from the type of power source indicated on the marking label. If you are not sure of the type of power supply to your home, consult your product dealer or local power company.

**LOCATION** — The appliance should be installed in a stable location.

**NONUSE PERIODS** — The power cord of the appliance should be unplugged from the outlet when left unused for a long period of time.

**GROUNDING OR POLARIZATION**

- If this product is equipped with a polarized alternating current line plug (a plug having one blade wider than the other), it will fit into the outlet only one way. This is a safety feature. If you are unable to insert the plug fully into the outlet, try reversing the plug. If the plug should still fail to fit, contact your electrician to replace your obsolete outlet. Do not defeat the safety purpose of the polarized plug.
- If this product is equipped with a three-wire grounding type plug, a plug having a third (grounding) pin, it will only fit into a grounding type power outlet. This is a safety feature. If you are unable to insert the plug into the outlet, contact your electrician to replace your obsolete outlet. Do not defeat the safety purpose of the grounding type plug.

**POWER-CORD PROTECTION** — Power-supply cords should be routed so that they are not likely to be walked on or pinched by items placed upon or against them, paying particular attention to cords at plugs, convenience receptacles, and the point where they exit from the product.

**OUTDOOR ANTENNA GROUNDING** — If an outside antenna or cable system is connected to the product, be sure the antenna or cable system is grounded so as to provide some protection against voltage surges and built-up static charges. Article 810 of the National Electrical Code, ANSI/NFPA 70, provides information with regard to proper grounding of the mast and supporting structure, grounding of the lead-in wire to an antenna discharge unit, size of grounding conductors, location of antenna-discharge unit, connection to grounding electrodes, and requirements for the grounding electrode. See Figure A.

**LIGHTNING** — For added protection for this product during a lightning storm, or when it is left unattended and unused for long periods of time, unplug it from the wall outlet and disconnect the antenna or cable system. This will prevent damage to the product due to lightning and power-line surges.

**POWER LINES** — An outside antenna system should not be located in the vicinity of overhead power lines or other electric light or power circuits, or where it can fall into such power lines or circuits. When installing an outside antenna system, extreme care should be taken to keep from touching such power lines or circuits as contact with them might be fatal.

**OVERLOADING** — Do not overload wall outlets, extension cords, or integral convenience receptacles as this can result in a risk of fire or electric shock.

**OBJECT AND LIQUID ENTRY** — Never push objects of any kind into this product through openings as they may touch dangerous voltage points or short-out parts that could result in a fire or electric shock. Never spill liquid of any kind on the product.

**SERVICING** — Do not attempt to service this product yourself as opening or removing covers may expose you to dangerous voltage or other hazards. Refer all servicing to qualified service personnel.

**DAMAGE REQUIRING SERVICE** — Unplug this product from the wall outlet and refer servicing to qualified service personnel under the following conditions:

- When the power-supply cord or plug is damaged.
- If liquid has been spilled, or objects have fallen into the product.
- If the product has been exposed to rain or water.
- If the product does not operate normally by following the operating instructions. Adjust only those controls that are covered by the operating instructions as an improper adjustment of other controls may result in damage and will often require extensive work by a qualified technician to restore the product to its normal operation.
- If the product has been dropped or damaged in any way.
- When the product exhibits a distinct change in performance — this indicates a need for service.

**REPLACEMENT PARTS** — When replacement parts are required, be sure the service technician has used replacement parts specified by the manufacturer or have the same characteristics as the original part. Unauthorized substitutions may result in fire, electric shock, or other hazards.

**SAFETY CHECK** — Upon completion of any service or repairs to this product, ask the service technician to perform safety checks to determine that the product is in proper operating condition.

**HEAT** — The product should be situated away from heat sources such as radiators, heat registers, stoves, or other products (including amplifiers) that produce heat.

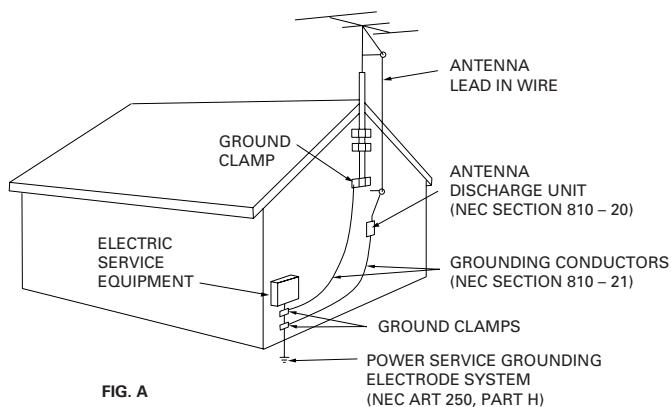

FIG. A

NEC - NATIONAL ELECTRICAL CODE

# IMPORTANT



The lightning flash with arrowhead symbol, within an equilateral triangle, is intended to alert the user to the presence of uninsulated "dangerous voltage" within the product's enclosure that may be of sufficient magnitude to constitute a risk of electric shock to persons.

## CAUTION

**RISK OF ELECTRIC SHOCK  
DO NOT OPEN**

**CAUTION:**  
TO PREVENT THE RISK OF ELECTRIC SHOCK, DO NOT REMOVE COVER (OR BACK). NO USER-SERVICEABLE PARTS INSIDE. REFER SERVICING TO QUALIFIED SERVICE PERSONNEL.



The exclamation point within an equilateral triangle is intended to alert the user to the presence of important operating and maintenance (servicing) instructions in the literature accompanying the appliance.

### [For Canadian model]

This Class B digital apparatus complies with Canadian ICES-003.

### [Pour le modèle Canadien]

Cet appareil numérique de la Classe B est conforme à la norme NMB-003 du Canada.

### Information to User

Alteration or modifications carried out without appropriate authorization may invalidate the user's right to operate the equipment.

This equipment has been tested and found to comply with the limits for a Class B digital device, pursuant to Part 15 of the FCC Rules. These limits are designed to provide reasonable protection against harmful interference in a residential installation. This equipment generates, uses, and can radiate radio frequency energy and, if not installed and used in accordance with the instructions, may cause harmful interference to radio communications. However, there is no guarantee that interference will not occur in a particular installation. If this equipment does cause harmful interference to radio or television reception, which can be determined by turning the equipment off and on, the user is encouraged to try to correct the interference by one or more of the following measures:

- Reorient or relocate the receiving antenna.
- Increase the separation between the equipment and receiver.
- Connect the equipment into an outlet on a circuit different from that to which the receiver is connected.
- Consult the dealer or an experienced radio/TV technician for help.



### Dear Customer:

Selecting fine audio equipment such as the unit you've just purchased is only the start of your musical enjoyment. Now it's time to consider how you can maximize the fun and excitement your equipment offers. This manufacturer and the Electronic Industries Association's Consumer Electronics Group want you to get the most out of your equipment by playing it at a safe level. One that lets the sound come through loud and clear without annoying blaring or distortion-and, most importantly, without affecting your sensitive hearing.

Sound can be deceiving. Over time your hearing "comfort level" adapts to higher volumes of sound. So what sounds "normal" can actually be loud and harmful to your hearing. Guard against this by setting your equipment at a safe level BEFORE your hearing adapts.

#### To establish a safe level:

- Start your volume control at a low setting.
- Slowly increase the sound until you can hear it comfortably and clearly, and without distortion.

#### Once you have established a comfortable sound level:

- Set the dial and leave it there.

Taking a minute to do this now will help to prevent hearing damage or loss in the future. After all, we want you listening for a lifetime.

## We Want You Listening For A Lifetime

Used wisely, your new sound equipment will provide a lifetime of fun and enjoyment. Since hearing damage from loud noise is often undetectable until it is too late, this manufacturer and the Electronic Industries Association's Consumer Electronics Group recommend you avoid prolonged exposure to excessive noise. This list of sound levels is included for your protection.

#### Decibel

Level	Example
30	Quiet library, soft whispers
40	Living room, refrigerator, bedroom away from traffic
50	Light traffic, normal conversation, quiet office
60	Air conditioner at 20 feet, sewing machine
70	Vacuum cleaner, hair dryer, noisy restaurant
80	Average city traffic, garbage disposals, alarm clock at two feet.

#### THE FOLLOWING NOISES CAN BE DANGEROUS UNDER CONSTANT EXPOSURE

90	Subway, motorcycle, truck traffic, lawn mower
100	Garbage truck, chain saw, pneumatic drill
120	Rock band concert in front of speakers, thunderclap
140	Gunshot blast, jet plane
180	Rocket launching pad

Information courtesy of the Deafness Research Foundation.



**[For Canadian model]**

**CAUTION:** TO PREVENT ELECTRIC SHOCK DO NOT USE THIS (POLARIZED) PLUG WITH AN EXTENSION CORD. RECEPTACLE OR OTHER OUTLET UNLESS THE BLADES CAN BE FULLY INSERTED TO PREVENT BLADE EXPOSURE.

**ATTENTION:** POUR PREVENIR LES CHOCS ELECTRIQUES NE PAS UTILISER CETTE FICHE POLARISEE AVEC UN PROLONGATEUR UNE PRISE DE COURANT OU UNE AUTRE SORTIE DE COURANT, SAUF SI LES LAMES PEUVENT ETRE INSEREES A FOND SANS EN LAISSER AUCUNE PARTIE A DECOUVERT.

## CAUTIONS REGARDING HANDLING

### Location

**Install the unit in a well-ventilated location where it will not be exposed to high temperatures or humidity.**

- Do not install the unit in a location which is exposed to direct rays of the sun, or near stoves or radiators. Excessive heat can adversely affect the cabinet and internal components. Installation of the unit in a damp or dusty environment may also result in a malfunction or accident. (Avoid installation near cookers etc., where the unit may be exposed to oily smoke, steam or heat.)
- When the unit is used inside a carrying case or DJ booth, separate it from the walls or other equipment to improve heat radiation.

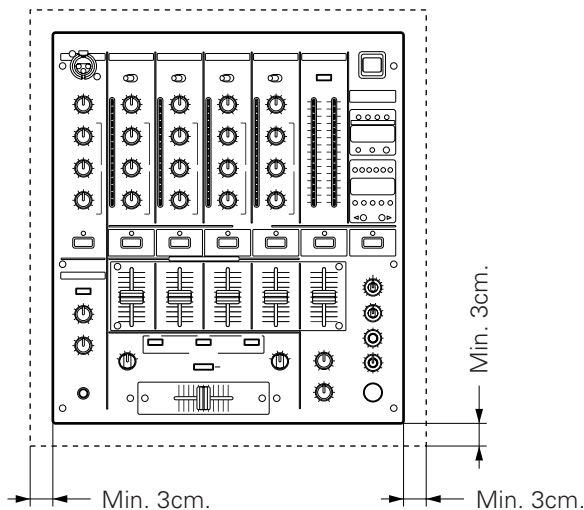

### Condensation

When this unit is brought into a warm room from previously cold surroundings or when the room temperature rises sharply, condensation may form inside, and the unit may not be able to attain its full performance. In cases like this, allow the unit to stand for about an hour or raise the room temperature gradually.

### Cleaning the Unit

- Use a polishing cloth to wipe off dust and dirt.
- When the surfaces are very dirty, wipe with a soft cloth dipped in some neutral cleanser diluted five or six times with water and wrung out well, then wipe again with a dry cloth. Do not use furniture wax or cleaners.
- Never use thinners, benzene, insecticide sprays or other chemicals on or near this unit, since these will corrode the surfaces.

# FEATURES

## BPM Sampler

Recognizes music BPM and records the set number of beats, making loop play possible that matches the BPM of the music being played.

## BPM Counter

The auto BPM counter provided makes music tempo visible to the eye.

## Peak Level Meter

The peak level meter provided is equipped with 15-bit LED indicators for all channels.

## Fader Start/Stop

The CD player can be started or stopped simply by increasing or decreasing the level of the cross fader or channel fader. (This function can only be used when the Pioneer CD player series CDJ-100S, CDJ-700S or CDJ-500 II is connected.)

The sampler can also be started with the cross fader.

## 3-Band Equalizer and Kill

This 3-band equalizer corresponds to the HI, MID, and LOW channels. The attenuation level also serves as a kill function, which can decrease the level to  $-26\text{dB}$ .

## Variety of Effects

Both internal and external effects can be applied to all channels, the microphone, and master.

A variety of effects can be enjoyed, including delay, echo, auto pan, auto trans, filter, flanger, reverb and pitch shifter.

## Enhanced Input/Output Terminals

In addition to the 10 inputs for the 2 CD, 3 LINE, 3 PHONO (for MM only) and 2 microphone systems, outputs for 2 systems, including the pro-specification XLR output, booth monitor output and recording output are provided independently. SEND/RETURN terminals are also provided for external effectors.

# CHECKING ACCESSORIES

- 6 short-circuit pin plugs  
These are inserted in the PHONO 1, PHONO 2, and PHONO 3 terminals on the back.
- Operating instructions
- Warranty

# CONTENTS

<b>CAUTIONS REGARDING HANDLING</b> .....	<b>4</b>
Location .....	4
Condensation .....	4
Cleaning the Unit .....	4
<b>FEATURES</b> .....	<b>5</b>
<b>CHECKING ACCESSORIES</b> .....	<b>5</b>
<b>CONNECTIONS</b> .....	<b>6</b>
<b>PART NAMES AND FUNCTIONS</b> .....	<b>8</b>
<b>USING THE EFFECT/SAMPLER FUNCTIONS</b> .....	<b>12</b>
Features of Various Effectors .....	12
Measuring BPM .....	14
Delay, Echo, Auto Pan, Auto Trans, Filter, and Flanger Operations .....	16
Operating Reverb and Pitch Shifter .....	18
Using an External Effector .....	19
Using Sampler Recording .....	20
Using Sampler Playback Functions .....	21
Using Sampler Edit Function .....	21
<b>USING THE FADER START FUNCTION</b> .....	<b>22</b>
Starting with the Channel Fader .....	23
Starting with the Cross Fader .....	23
<b>TROUBLESHOOTING</b> .....	<b>24</b>
<b>SPECIFICATIONS</b> .....	<b>25</b>

# CONNECTIONS

When connecting or changing the connection of units, make sure to first turn off the power switch and disconnect the power cord from the outlet.

## 1. Connection of Input Equipment

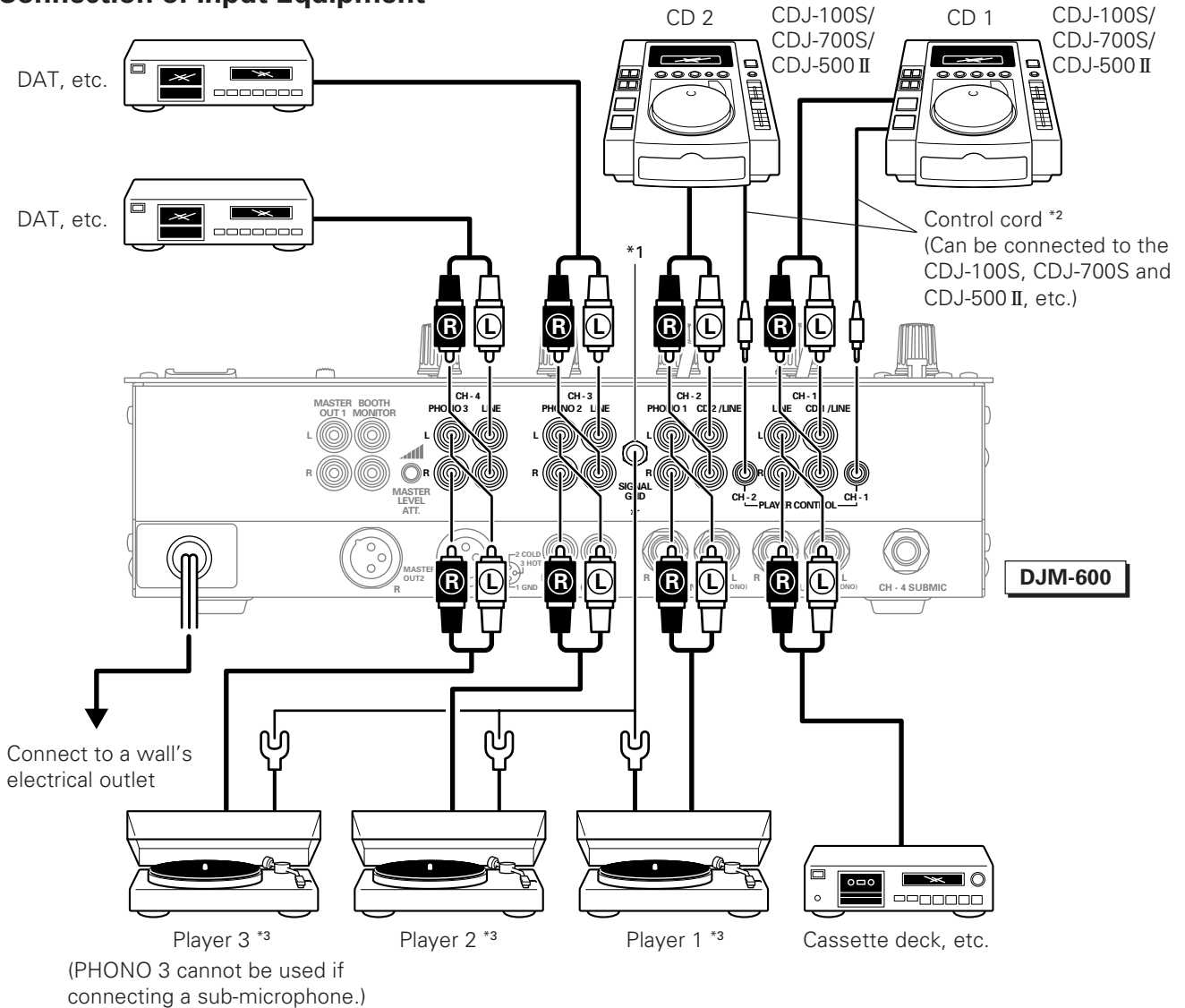

If connecting an analog player, remove the six short-circuit pin plugs inserted in the PHONO terminals (PHONO 1, PHONO 2 and PHONO 3) of CH-2, CH-3, and CH-4. These short-circuit pin plugs serve to cut fine noise, ensuring outstanding performance when no analog player is connected. Make sure to store the plugs carefully after removing them. When you disconnect an analog player, reinsert the plugs as they were originally.

- \*1 Connect the cord for the analog player's ground. This terminal is exclusively for an analog player and is not a safety earth.
- \*2 If you are using the unit with the separately sold CDJ-100S, CDJ-700S, or CDJ-500 II connected to the CH-1 or CH-2 CD terminals, the fader start function can be used if the unit and CD player are connected with a control cord.
- \*3 Because the unit's PHONO input terminals are exclusively for MM, use MM-type cartridges for the analog player connected.

### Connecting audio cords

Use the cords with the red and white pin plugs. Connect the white plug to "L" and the red plug to "R". Make sure to insert the plugs completely.

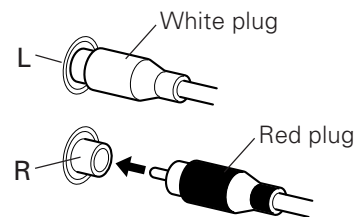

2. Connection of Outputs, Microphones, etc.

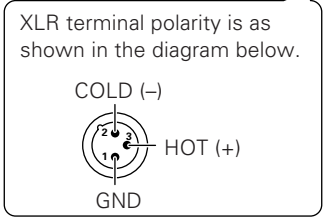
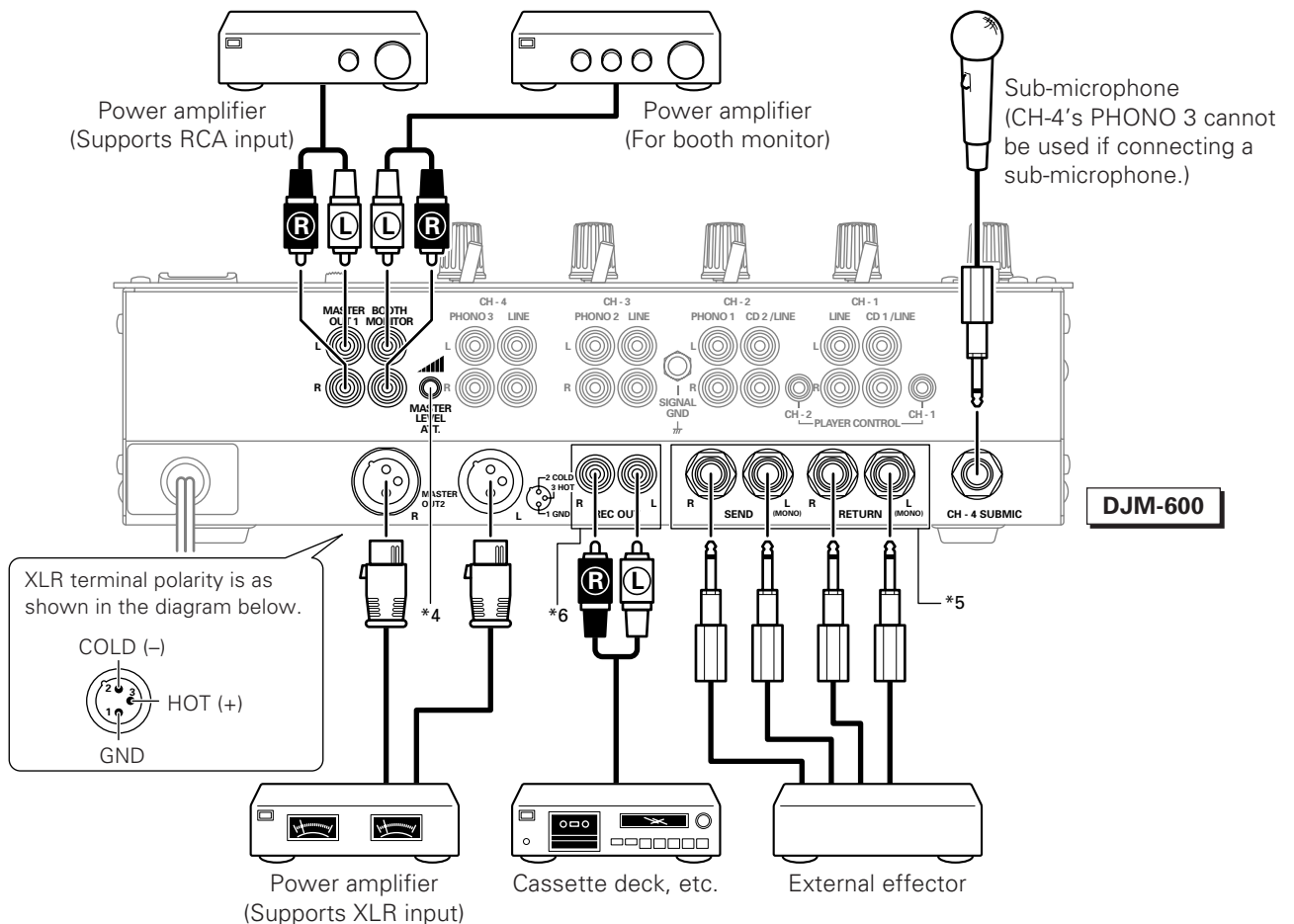
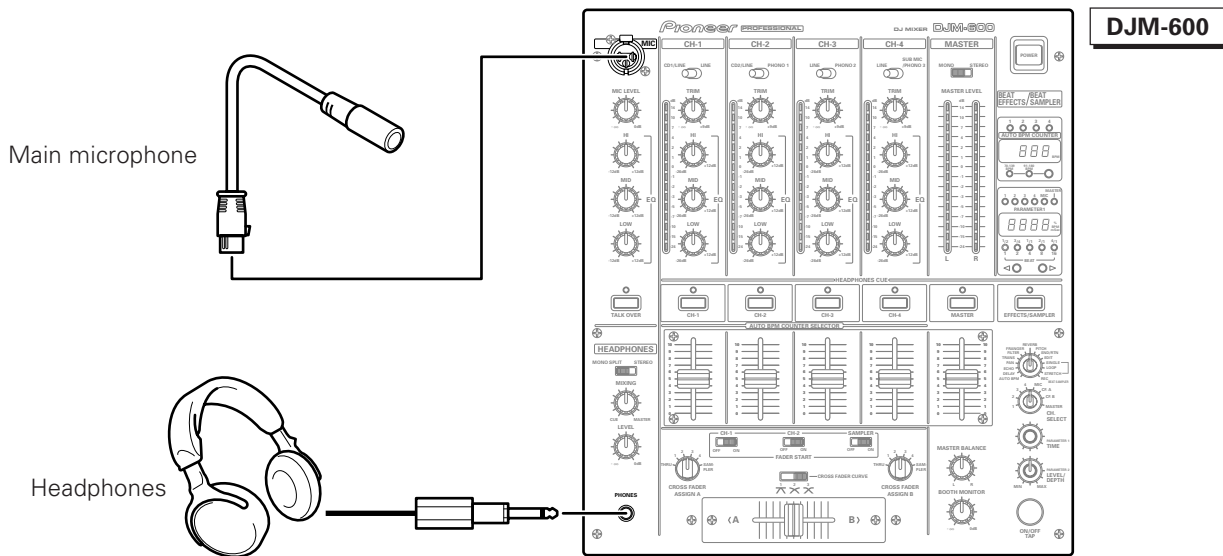

- \*4 **MASTER LEVEL ATT.**  
(Master output-level attenuator knob)  
This knob is used to decrease the output level to protect connected amplifiers and speakers from excessive input. (Attenuation:  $-\infty$  to 0dB)
- \*5 Connect if you want to use another device for adjusting sound quality.  
**SEND** (output):  
Connect this to the external effector's input terminal. When using a monaural input effector, connect it to the L channel output. The effector will receive LR-mixed sound.

- RETURN** (input):  
Connect this to the external effector's output terminal. When using a monaural output effector, connect it to the L channel output. The signals from the effector will be input to both the L and R channels.
- \*6 **REC OUT.**  
Outputs sound to the same output source as the master output, without being influenced by the master volume, master balance and MONO switches.

# PART NAMES AND FUNCTIONS

## Control Panel

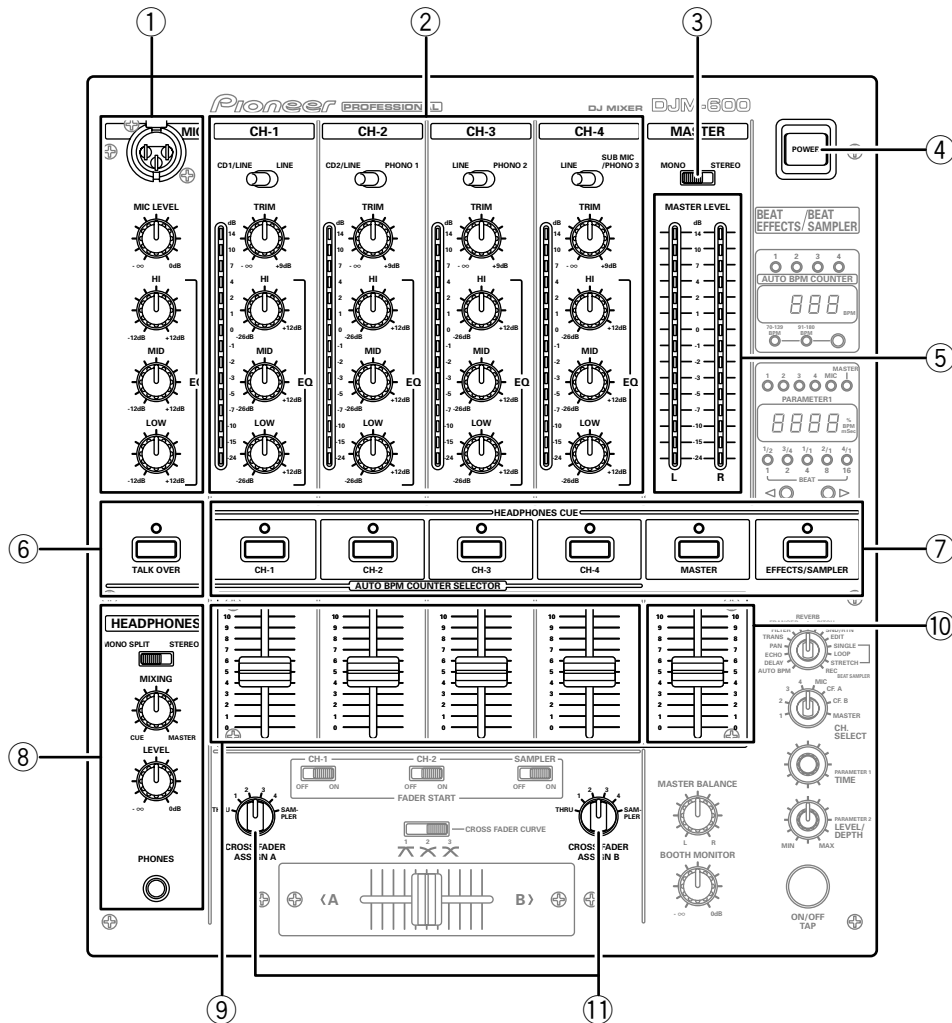

### ① Main Microphone Input Terminal and Microphone Control Knob

#### Main Microphone Input Terminal:

For connecting a microphone that has a cannon-type terminal.

#### MIC LEVEL (microphone level):

Adjusts the volume of the main microphone.  
(Attenuation:  $-\infty$  to 0dB)

#### HI:

Adjusts high-tone microphone sound.  
At the center position, sound is flat.  
Turn to the right to increase sound (to +12dB at 10kHz).  
Turn to the left to decrease sound (to -12dB at 10kHz).

#### MID:

Adjusts mid-tone microphone sound.  
At the center position, sound is flat.  
Turn to the right to increase sound (to +12dB at 1kHz).  
Turn to the left to decrease sound (to -12dB at 1kHz).

#### LOW:

Adjusts low-tone microphone sound.  
At the center position, sound is flat.  
Turn to the right to increase sound (to +12dB at 100Hz).  
Turn to the left to decrease sound (to -12dB at 100Hz).

### ② Input Selector Switches, Control Knobs, and Peak Level Meters for CH-1 to CH-4

#### Input Selector Switches:

These switches select what input source to use from among the units connected to each channel.  
CH-1: Switches between CD1/LINE and LINE  
CH-2: Switches between CD2/LINE and PHONO 1  
CH-3: Switches between LINE and PHONO 2  
CH-4: Switches between LINE and SUB MIC/PHONO 3

#### TRIM:

Adjusts the input signal level.  
Turn to the right to increase level (to +9dB).  
Turn to the left to decrease level (to  $-\infty$ ).



**HI:**

Adjusts high-tone input sounds.  
 At the center position, sound will be flat.  
 Turn to the right to increase sound (to +12dB at 13kHz).  
 Turn to the left to decrease sound (to -26dB at 13kHz).

**MID:**

Adjusts mid-tone input sound.  
 At the center position, sound will be flat.  
 Turn to the right to increase sound (to +12dB at 1kHz).  
 Turn to the left to decrease sound (to -26dB at 1kHz).

**LOW:**

Adjusts low-tone input sound.  
 At the center position, sound is flat.  
 Turn to the right to increase sound (to +12dB at 70Hz).  
 Turn to the left to decrease sound (to -12dB at 70Hz).

**Peak Level Meter:**

Displays peak level, held for 2 seconds.  
 Displays level before it is subjected to the channel fader.  
 Display range: -24dB to +14dB.

**③ MONO/STEREO (Master Output Monaural/Stereo Selection Switch)**

Used to select either MONO or STEREO for master output.

**④ POWER (Power Supply Switch)****⑤ MASTER LEVEL (Master Level Meter)**

Displays the output level following master volume adjustment, held for 2 seconds.  
 Display range: -24dB to +14dB.

**⑥ TALK OVER**

Press this switch and the sound level for everything other than the main microphone will decrease to around 14dB, and a red LED will light. To restore original status, press this switch again.

**Caution:** Pressing this switch will cause sudden, major changes in the volume.

**⑦ HEADPHONES CUE and AUTO BPM COUNTER SELECTOR****HEADPHONES CUE:**

Used to select the source (CH-1 to CH-4, MASTER, or EFFECTS/SAMPLER) to be monitored with headphones. Press it again to cancel the selection.  
 Pressing multiple buttons makes it possible to derive mixed sound from the selected sources.

**AUTO BPM COUNTER SELECTOR:**

When AUTO BPM has been selected with the effect/sampler selector switch (19), the BPM of the selected channel (CH-1 to CH-4) will be displayed on the BPM display (17).

BPM will not be displayed correctly if 2 or more channels have been selected.

**⑧ Headphone Terminal and Headphone Output Control Panel****MONO SPLIT/STEREO****(mono split/stereo selector switch):**

Used to select whether to split monitor sound on the left and right of the headphones or to keep sound in stereo form.

MONO SPLIT will change headphone output to monaural.

The left channel will be for the sound from the channel selected with HEADPHONES CUE, and the right channel will be the sound output from the master. (This applies only when the master was selected using HEADPHONES CUE.)

**MIXING (mixing adjustment knob):**

Adjusts headphone monitor sound.

Turn all the way to the right for master output sound. (This applies only when the master was selected using HEADPHONES CUE.)

Turn all the way to the left for the sound from the channel (other than the master) selected with HEADPHONES CUE.

At the center position, the levels for master output and the sound selected with HEADPHONES CUE will be even.

**LEVEL (level adjustment knob):**

Adjusts headphone monitor sound.

When CH-1 to CH-4 has been selected, the level is not affected by master volume (10) or master balance (15).

**PHONES (headphone terminal)****⑨ Channel Fader Volume**

Adjusts the volume for CH-1 to CH-4.

**⑩ Master Fader Volume**

Adjusts the master output sound level. Signals from the channels selected with the ASSIGN switch (11) will be output using channel fader volume (9) and cross fader volume (14), while signals from other channels will be output using channel fader volume.

**⑪ CROSS FADER ASSIGN A, CROSS FADER ASSIGN B**

Selects signals assigned to A and B when the cross fader is used with 2 sources (A and B).

THRU: Select when not using the cross fader.

1 to 4: Select what channels (CH-1 to CH-4) to assign to A and B.

Channels not assigned to A or B are output without passing through the cross fader.

SAMPLER: Select when using the cross fader to output sound sampled using this unit's effect function, when SINGLE (not STRETCH or LOOP) has been selected with the effect/sampler selector switch (19).

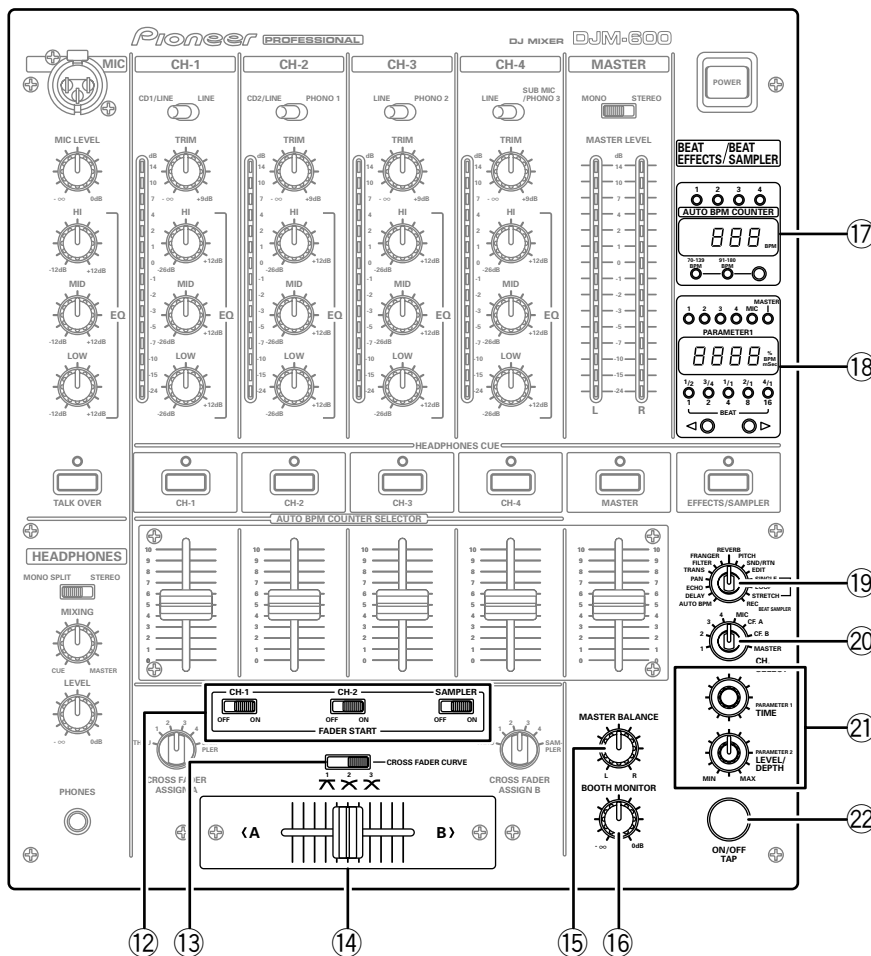

**12 FADER START (Fader Start ON/OFF Switch) CH-1 and CH-2:**

When the unit has been connected with a control cable to a CDJ-100S, CDJ-700S or similar CD player, this is the ON/OFF switch for the function to automatically start playing of the CD player using the channel fader or cross fader.

**SAMPLER:**

This is the ON/OFF switch for the function to start the unit's built-in sampler using the cross fader.

**13 CROSS FADER CURVE (Cross Fader Curve Selection Switch)**

Used to select one of 3 cross fader startup curves.

**14 Cross Fader Volume**

Used to adjust the sound mix volume of the sources set to A or B using the ASSIGN switch (11).

**15 MASTER BALANCE Knob**

Used to adjust the left-right balance of the master output.

**16 BOOTH MONITOR Level Knob**

Used to adjust the level of the BOOTH MONITOR output terminal on the rear panel. Level is not affected by the master volume (10) and master balance (15).

**17 BPM Display (see page 14)**

When AUTO BPM has been selected using the effect/sampler selector switch (19), displays BPM for the channel (CH-1 to CH-4) selected using AUTO BPM COUNTER SELECTOR (7).

**1 to 4:**

Displays the channel that is measuring BPM.

**AUTO BPM COUNTER:**

Displays BPM values.

Flashes while measuring or if unable to measure BPM.

**BPM Measurement Range Display/****BPM Measurement Range Selector Switches:**

- Used for making selections from the following: 70 to 139, 91 to 180, 70 to 180, and manual mode. When both LEDs are lit, the 70 to 180 setting applies. When neither LED is lit, manual mode applies. Set the BPM band to match the music for which BPM will be measured.
- For details on manual mode, see “Measuring BPM” on pages 14 and 15.

When the effect/sampler channel selector switch has been used to select something other than AUTO BPM, the BPM of the source selected with the effect/sampler channel selector switch (20) will be displayed.

**18 Effect Parameter and BPM Display (see page 17)****1 to 4, MIC, and MASTER:**

Displays the source selected with the effect/sampler channel selector switch (20).

When CF. A or CF.B has been selected with the effect/sampler channel selector switch, the channels (1 to 4) selected with the ASSIGN switches (11) will light.

**PARAMETER (Parameter/BPM Counter):**

The display will differ with the setting of the effect/sampler selector switch (19).

- When AUTO BPM has been selected, the BPM for the source selected with the effect/sampler channel selector switch will be displayed. Display will flash while BPM is being measured or cannot be measured.
- Nothing will be displayed if SEND/RETURN has been selected.
- If something other than AUTO BPM and SEND/RETURN has been selected, the effect value set with effect parameter 1 (21) will be displayed.

**BEAT (Effect Synchronous Display/Beat Display):**

The display will differ with the setting of the effect/sampler selector switch (19).

- If DELAY, ECHO, PAN or TRANS has been selected, parameter 1 for source BPM will be displayed in terms of a beat. It will light if the beat is 1/2 or 4/1. Pressing the (◀) effect beat selector switch will change beats under 1/2 to 1/4, clearing the display entirely. Pressing the (▶) effect beat selector switch will change beats over 4/1 to 8/1, clearing the display entirely. If there is a disparity between the number of beats, the closest number will be displayed blinking.
- If FILTER, FLANGER or SAMPLER has been selected, parameter 1 for source BPM will be displayed in terms of a beat. The display will light if it matches 1 to 16 beats. Pressing the (◀) effect beat selector switch when there is less than 1 beat will change the beat to 1/2, clearing the display entirely. Pressing the (▶) effect beat selector switch for over 16 beats will change the number of beats to 32, clearing the display entirely. If there is a disparity between the number of beats, the closet number will be displayed blinking.
- If PITCH has been selected, the extent of pitch adjustment will be displayed.
- If REVERB has been selected, the amount of reverberation will be displayed.
- Nothing will be displayed if AUTO BPM or SEND/RETURN has been selected.

**Effect Beat Selector Switch:**

The value for effect/sampler parameter 1 (21) will change in keeping with the BPM for source selected with the effect/sampler channel selector switch (20).

The set value will change with the effect/sampler selector switch (19) setting.

- If DELAY, ECHO, PAN or TRANS has been selected, parameter 1 for source BPM will be set in terms of a beat (1/4~8/1).
- If FILTER, FLANGER or SAMPLER has been selected, parameter 1 for source BPM will be set in terms of a number of beats (1/2 to 32).
- If DELAY or ECHO has been selected, the number of beats for parameter 1 cannot be set in excess of 3500ms.
- If SAMPLER has been selected, the number of beats for parameter 1 cannot be set in excess of 8000ms.
- If PITCH has been selected, settings of -100%, -50%, -33%, 0%, 33%, 50% and 100% will be possible.
- If REVERB has been selected, settings of 10%, 20%, 35%, 50%, 65%, 80% and 90% will be possible.
- This switch will not function if AUTO BPM or SEND/RETURN has been selected.

**19 Effect/Sampler Selector Switch**

Used to select different effects (see page 14).

**20 CH. SELECT (Effect/Sampler Channel Selector Switch)**

Used to select the source to be effected.

**21 PARAMETER 1, 2 (Effect/Sampler Parameter 1 and 2 Knobs)**

Used to adjust the values of the parameters of the built-in effector and the sampler (see page 16).

**22 ON/OFF, TAP (Effect/Sampler ON/OFF Switch and Tap Switch)**

Effect will differ with the setting of the effect/sampler selector switch (19).

- Functions as the effect's ON/OFF switch if DELAY, ECHO, PAN, TRANS, FILTER, FLANGER, REVERB, PITCH, or SEND/RETURN has been selected. (OFF: Orange light. ON: Blinking orange light.)
- When AUTO BPM has been selected, it will function as a tap switch, enabling it to be used as a beat counter through manual input. (Selection indicated by orange light.) When using the tap switch to measure BPM, both LEDs for indicating the BPM measurement range will turn off and manual mode will go into effect (see page 15).
- Functions as the ON/OFF switch for sampler recording when SAMPLER REC has been selected (see page 20). (REC OFF: Red light. REC ON: Blinking red light.)
- Functions as the ON/OFF switch for sampler playback when SAMPLER PLAY has been selected (see page 21). (PLAY OFF: Green light. PLAY ON: Blinking green light.)

# USING THE EFFECT/SAMPLER FUNCTIONS

With the built-in digital signal processor (DSP), sound effects can be enjoyed and BPM measured.

## Features of Various Effectors

### Auto BPM Counter

Automatically measures music BPM (beats per minute; tempo) and displays it digitally.

It not only counts the beat of bass sounds but also calculates (using a computer) the music's original BPM, which DJs require, and displays it digitally.

Thus, BPM can now be checked not only aurally, as was conventional, but also visually, enabling quicker, simpler mixing of music with different tempos.

Use of the TAP switch to input the beat manually makes it possible to set BPM for music for which it is difficult to measure (a capella, improvisation, etc.).

### Beat Effector (Effects linked to BPM)

Links various effects to the BPM calculated with the aforementioned auto BPM counter to enable unprecedented sound production.

#### 1. DELAY (one sound repeated)

Quickly and easily mixes delayed sounds of 1/4, 1/2, 3/4, 1/1, 2/1, 4/1 and 8/1 beats.

Mixing with 1/2-beat-delayed sound, for example, will change the beat from 4 to 8.

Mixing with a 3/4-beat-delayed sound will change the rhythm to a bouncy one.

Example:

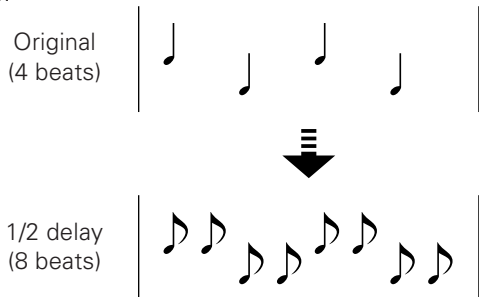

#### 2. ECHO (repeated sounds)

Quickly and easily mixes echoes of 1/4, 1/2, 3/4, 1/1, 2/1, 4/1 and 8/1 beats.

When input sound is cut with a 1/1-beat echo, for example, the music will fade out while sounds are repeated that match the beat.

When a 1/1-beat echo is imposed on the microphone, microphone sound will be played repeatedly, matching the beat.

Troll (musical round-type) effects can be produced by imposing a 1/1-beat echo on song vocals.

Example:

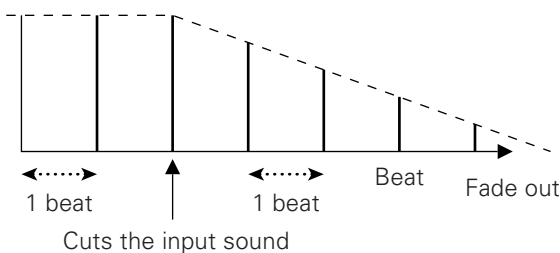

#### 3. Auto Pan [PAN (L-R BALANCE)]

Automatically pans sound to the left and right (auto beat pan) to the rhythm of a 1/4, 1/2, 3/4, 1/1, 2/1, 4/1 or 8/1 beat.

Short auto pan, for panning sound to the left and right in a short time that cannot be covered manually, is also possible.

Example:

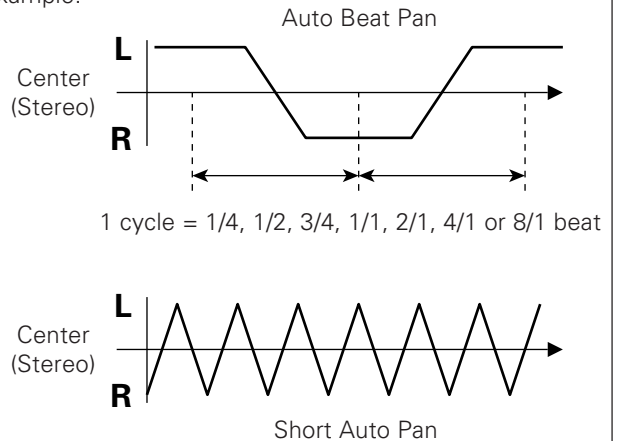

#### 4. Auto Trans (TRANS)

Automatically cuts sound to the rhythm of a 1/4, 1/2, 3/4, 1/1, 2/1, 4/1 or 8/1 beat.

Example:

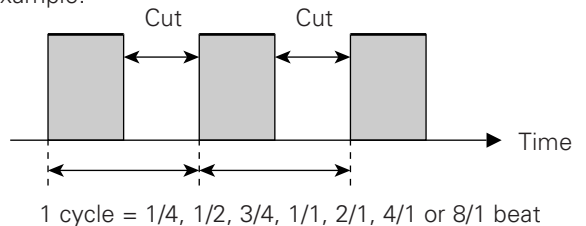

**5. FILTER**

Changes the tone greatly by shifting the filter's frequency in units of 1/2, 1, 2, 4, 8, 16, and 32 beats.

Example

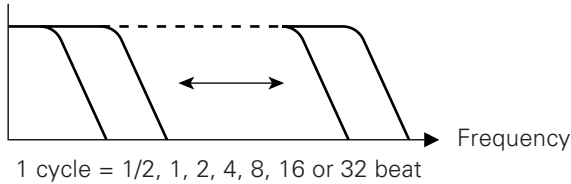

**6. FLANGER**

Quickly and easily produces 1-cycle flanger effect for beats of 1/2, 1, 2, 4, 8, 16, or 32.

Example

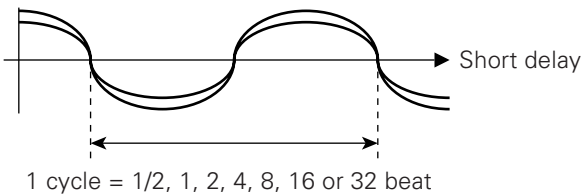

**7. REVERB**

Produces a reverberation effect.

**8. PITCH (Pitch Shifter)**

Shifts interval (pitch or key) within a range of ±1 octave. As the speed of analog-record turntables and CD players changes as a percent, interval changes can be corrected on a percent basis.

Applying the pitch shifter to microphone sound produces voice changer effects. Mixing with original sound produces a choral effect.

**9. SEND/RETURN (External effect input/output)**

Makes diverse effects possible through connection to available effectors, samplers, etc.

**10. SAMPLER REC**

Recognizes music BPM and samples in terms of the set beat.

Example

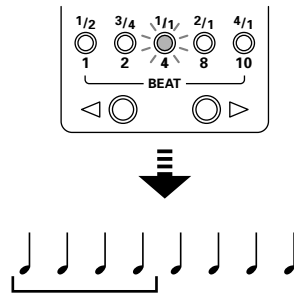

**11. SAMPLER PLAY**

**Stretch Loop**

Plays while automatically shortening and lengthening the BPM of sampled sound to the BPM of different music.

Example

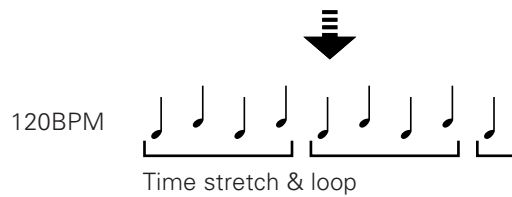

**Loop**

Plays sampled sound to a different beat.

Example

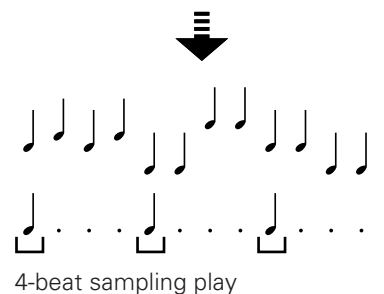

## USING THE EFFECT/SAMPLER FUNCTIONS

### Measuring BPM

Measurement and display of the BPM of channels selected with the auto BPM counter selector and of channels selected with the effect/sampler channel selector switch make it easy to mix music of different tempos. (Range of measurement: 70.0 to 180.0 BPM)

Example: Displaying the BPM of music for auto BPM counter selector CH-1 and effect/sampler channel selector switch 2 (CH-2).

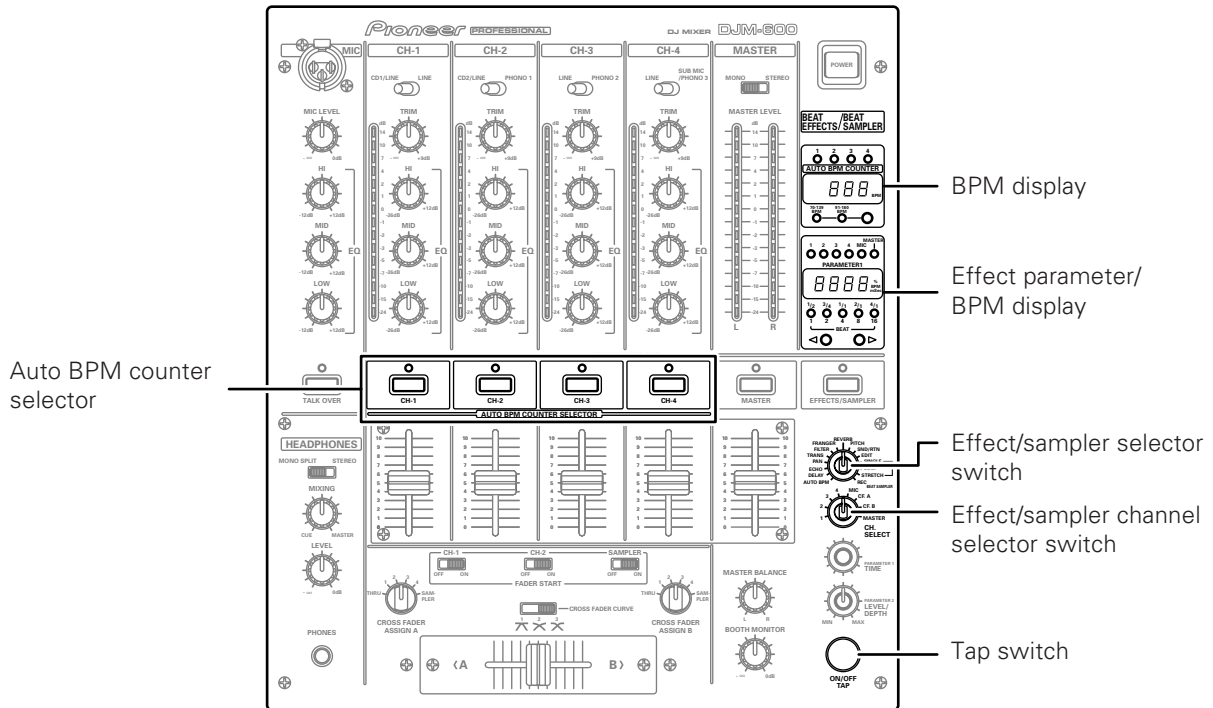

**1 Set the effect/sampler selector switch to AUTO BPM.**

**2 Press the BPM measurement range selector switch and select the BPM band for CH-1 and CH-2.**

- From the options of 70 to 139, 91 to 180, and 70 to 180, select the BPM band that matches the BPM of the music to be measured.
- When both LEDs are lit, 70 to 180 has been selected.

**3 Set the effect/sampler channel selector switch to 2.**

- LED "2" on the effect parameter/BPM display will light.
- The BPM of the music input to CH-2 will be displayed on the effect parameter/BPM display's counter.
- \* LED will blink if BPM cannot be measured for more than 2 seconds.
- \* Depending on the music, it might not be possible to measure BPM with the auto BPM counter. In this case, use manual mode to make settings (see page 15).

**4 Press auto BPM counter selector CH-1.**

- LED "1" on the BPM display will light.
- The BPM of the music input to CH-1 will be displayed on the BPM display's counter.
- \* To measure BPM accurately, select only one channel (CH-1 to CH-4) for the auto BPM counter.

**BPM display**

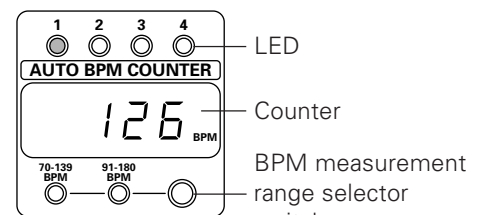

**Effect parameter/BPM display**

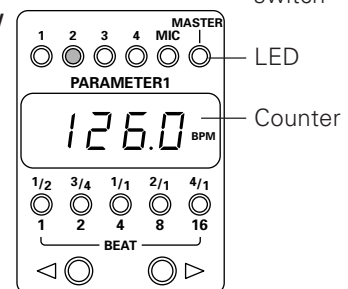

- Display when the BPM of CH-1 and CH-2 (126) match.

**Measuring BPM in Manual Mode**

- **When BPM cannot be measured in auto BPM mode:**  
 If auto BPM measurement is not possible, use the tap switch for manual input.
  - When the tap switch is pressed in time to the music's beat, the light in both BPM measurement range displays will turn off and manual mode will go into effect.
  - The BPM value input with the tap switch will be displayed on the effector/BPM display's lower counter, and the display on the upper counter will turn off.
  - To return to auto BPM mode, press the BPM measurement range selector switch and set the measurement range.

- **When BPM cannot be measured during delay, echo, auto pan, auto trans, filter and flanger operations (pages 16 and 17), or during sampler operations (pages 20 and 21):**  
 If BPM cannot be measured for more than 2 seconds during effect or sampler operations, the BPM display's counter will blink. In such a case, change the effect/sampler selector switch to AUTO BPM and use the tap switch for manual input.
  - After the BPM value input via the tap switch has been displayed on the effect parameter/BPM display's lower counter and the effect/sampler selector switch restored to the original effect, the BPM value input will be displayed on the BPM display's upper counter.

BPM can be input in manual mode if the music's BPM is known in advance.

- Change the effect/sampler selector switch to AUTO BPM and press the BPM measurement range selector switch and both BPM measurement range displays will turn off.
- If the effect/sampler parameter 1 knob (TIME) is pressed, the counter on the effect parameter/BPM display will display the BPM, with adjustment possible from the first digit.

Turning the parameter 1 knob while pressing the tap switch makes it possible to adjust the BPM from the first decimal place.

When the BPM value has been set and the effect/sampler selector switch restored to the original effect, the BPM value set will be displayed on the BPM display's counter.

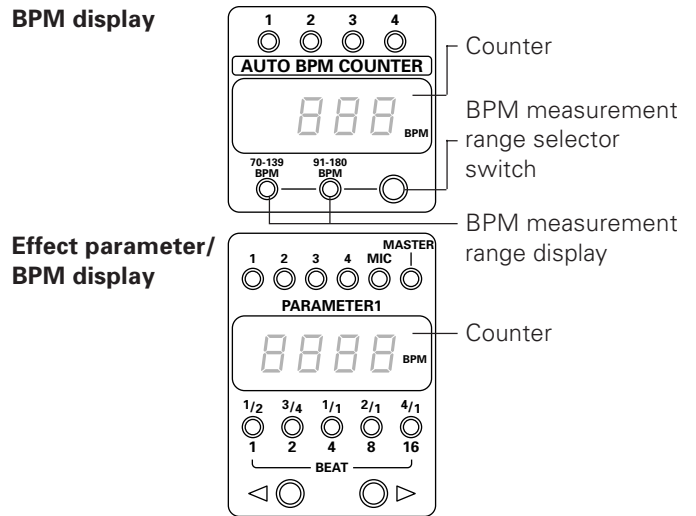

## USING THE EFFECT/SAMPLER FUNCTIONS

### Delay, Echo, Auto Pan, Auto Trans, Filter, and Flanger Operations

#### Items Set for Each Effect

Effect	Effect/sampler parameter 1 (TIME)	Effect/sampler parameter 2 (LEVEL/DEPTH)
<b>DELAY</b>	Delay time Setting range: 1 to 3500mSec, in 1msec steps	Effect mix ratio (Balance between original and delayed sound levels)
<b>ECHO</b>	Delay time Setting range: 1 to 3500mSec, in 1msec steps	Effect mix ratio (Balance between original and echo sound levels)
<b>PAN</b> (Auto pan)	Pan time (changeover time) Setting range: 10 to 16000mSec, in 5mSec steps for 10 to 1000 and 10msec steps for 1000 to 16000	Effect mix ratio (Balance between original and panned sound levels)
<b>TRANS</b>	Trans time (changeover time) Setting range: 10 to 16000mSec, in 5mSec steps for 10 to 1000 and 10msec steps for 1000 to 16000	Effect mix ratio (Balance between original and panned sound levels)
<b>FILTER</b>	Filter time (cycle) Setting range: 10 to 16000mSec, in 5mSec steps for 10 to 1000 and 10msec steps for 1000 to 16000	Resonance (Filter resonance sound level)
<b>FLANGER</b>	Flanger time (cycle) Setting range: 10 to 16000mSec, in 5mSec steps for 10 to 1000 and 10msec steps for 1000 to 16000	Feedback (Flanger feedback sound level)

Example: Applying the delay effect to music on CH-2.

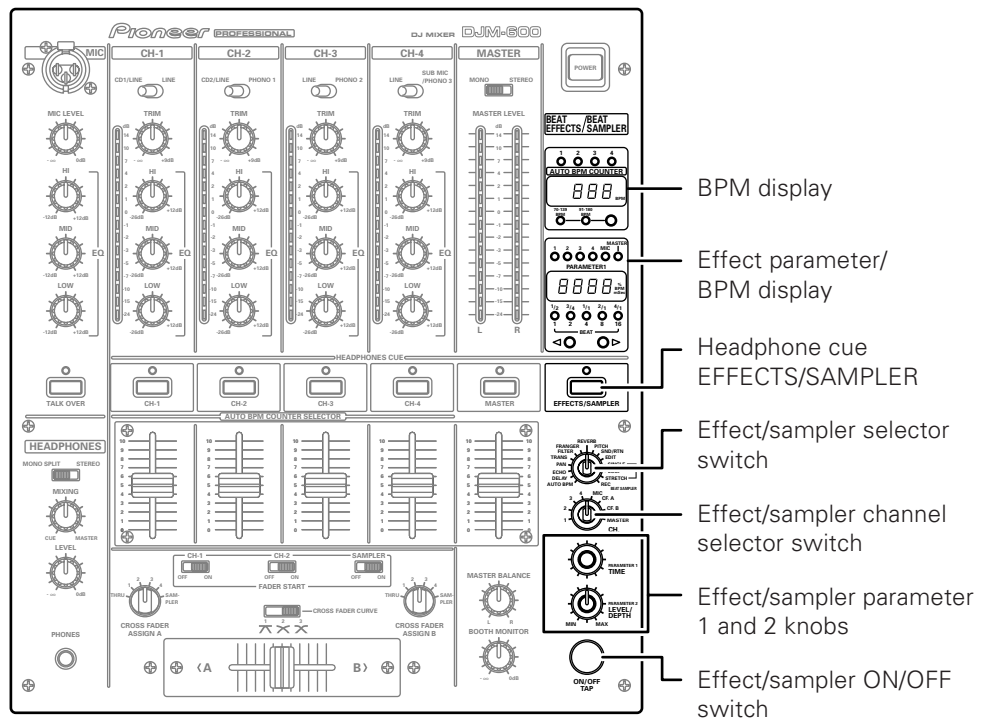



**1 Set the effect/sampler selector switch to DELAY.**

**2 Set the effect/sampler channel selector switch to 2.**

- LED "2" on the effect parameter/BPM display will light.
- The BPM of the music input to CH-2 will be displayed on the BPM display's counter.
- \* The BPM band that matches the music on CH-2 can be selected with the BPM measurement range selector switch.
- \* LED will blink if BPM cannot be measured for more than 2 seconds. In this case, use manual mode to make settings (see page 15).

**3 Set the parameter value.**

When headphone cue's EFFECTS/SAMPLER is pressed, effect sound can be confirmed via headphone output.

**Setting the Delay Time**

- Setting the delay time to match one beat of the BPM displayed on the BPM display's counter makes effect application more effective.
- By pressing the effect beat selector switch, delay time of 1/4 to 8/1 can be set for one beat of the measured BPM.
- More precise delay times can be set with the effect/sampler parameter 1 knob (TIME).
- As "1/2" will light on the beat display if delay time is set to 1/2 of one beat of the BPM, the parameter value can be set using the beat display as a guide.

**Setting to Balance Original and Delayed Sound Levels**

- The balance between original and delayed sound levels is set using the effect/sampler parameter 2 knob (LEVEL/DEPTH). Turning this knob to the left will decrease delayed sound and turning it to the right will increase it.

**4 Turn on the effect/sampler ON/OFF switch.**

- The effect/sampler ON/OFF switch will blink orange, and the delay effect will be applied to master output.
- If the switch is pressed once more, the effect will be turned off.
- \* If it is turned on in time to the beat, the effect's cycle will also start on the beat.

Echo, auto pan, auto trans, filter, flanger can also be set similarly.

**Precautions:**

- If the channel has been changed with the effect/sampler

channel selector switch when delay, echo, reverb (pages 18 and 19) and similar effects have been turned on, all of the reverberation of the prior channel's effects will be output.

- Only operate the effect/sampler selector switch when effects are off (when the effect/sampler ON/OFF switch is lit orange). Operating it with effects on could generate noise.

**BPM display**

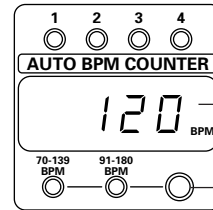

- Counter
- BPM measurement range selector switch

**Effect parameter/BPM display**

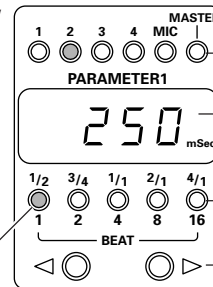

- LED
  - Counter
  - Beat display
  - Effect beat selector switch
- "1/2" will light

- Display where a 1/2-beat delay (250mSec) has been set to music with a BPM of 120 (time conversion: 500mSec).

## USING THE EFFECT/SAMPLER FUNCTIONS

### Operating Reverb and Pitch Shifter

#### Effector Settings

Effect	Effect/sampler parameter 1 (TIME)	Effect/sampler parameter 2 (LEVEL/DEPTH)
<b>REVERB</b>	Reverb time (echo time) Setting range: 1 to 100%, in 1% steps	Effect mix ratio (Balance between original and reverb sound levels)
<b>PITCH</b> (Pitch Shifter)	Delay time Setting range: 0 to $\pm 100\%$ , in 1% steps	Effect mix ratio (Balance between original and pitch-shifted sound levels)

Example: Display when music on CH-3 has been pitch-shifted 90%.

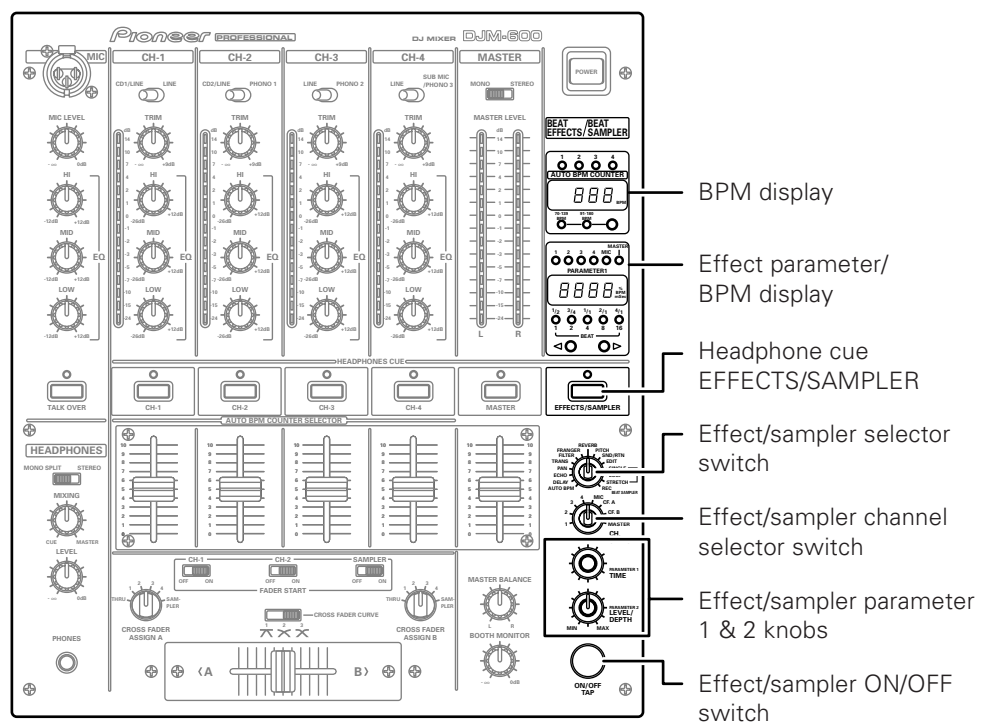

1 Set the effect/sampler selector switch to **PITCH**.

2 Set the effect/sampler channel selector switch to **3**.

- LED "3" on the effect parameter/BPM display will light.
- \* The entire BPM display will turn off.

3 Set the parameter value.

When headphone cue's EFFECTS/SAMPLER is pressed, effect sound can be confirmed via headphone output.

#### Setting Pitch

- Pressing ► on the effect beat selector switch will increase the pitch setting +33%, +50% or +100%, while pressing ◀ will decrease it -33%, -50% or -100%.
- More precise pitch can be set with the effect/sampler parameter 1 knob (TIME).

#### Setting the Balance Between Original and Pitch-Shifted Sound Levels

- The balance between original and pitch-shifted sound levels is set using the effect/sampler parameter 2 knob (LEVEL/DEPTH). Turning this knob to the left will decrease pitch-shifted sound and turning it to the right will increase it.

4 Turn the effect/sampler ON/OFF switch on and then off again.

- The effect/sampler ON/OFF switch will blink orange and the effect (pitch shift) will be applied to master output.
- If the switch is pressed once more, the effect will turn off.

Reverb can be set similarly.

**Precautions:**

- If the channel has been changed with the effect/sampler channel selector switch when delay, echo (pages 16 and 17), reverb and similar effects have been turned on, all of the reverberation of the prior channel's effects will be output.
- Only operate the effect/sampler selector switch when effects are off (when the effect/sampler ON/OFF switch is lit orange). Operating it with effects on could generate noise.

**BPM display**

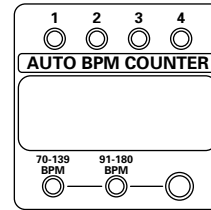

**Effect parameter/  
BPM display**

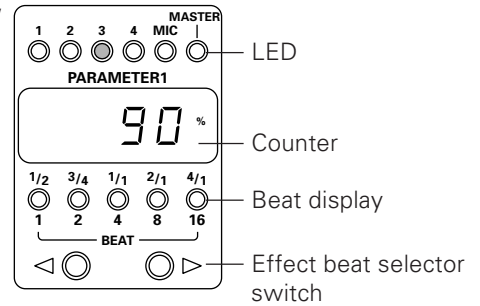

- Display when CH-3 has been pitch-shifted by 90%.

**Using an External Effector**

The following example is for applying external effects to music on CH-3.

- 1 Set the effect/sampler selector switch to SEND/RETURN.**
- 2 Set the effect/sampler channel selector switch to 3.**
  - LED "3" on the effect parameter/BPM display will light.
- 3 Set external effector parameters, etc.**
  - When headphone cue's EFFECTS/SAMPLER is pressed, effect sound can be confirmed via headphone output.
- 4 Adjust the return level.**
  - The return level from the external effector can be adjusted with the effect/sampler parameter 2 knob.
  - \* Effect/sampler parameter 1 knob (TIME) will not function.
- 5 Turn on the effect/sampler ON/OFF switch.**
  - The effect/sampler ON/OFF switch will blink orange, and the external effect will be applied to music on CH-3.
  - Pressing the switch once more will turn the effect off.

**BPM display**

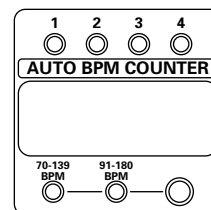

**Effect parameter/  
BPM display**

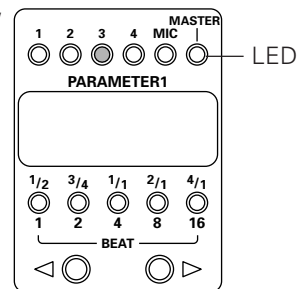

- Display when an external effect has been applied to CH-3.

## USING THE EFFECT/SAMPLER FUNCTIONS

### Using Sampler Recording

The unit's built-in sampler recognizes the BPM of music to be recorded and automatically records the specified number of beats (1, 2, 4, 8, or 16) only. The maximum recording time is eight seconds.

Example: When recording 8 beats of the piece on CH-1 (BPM=120).

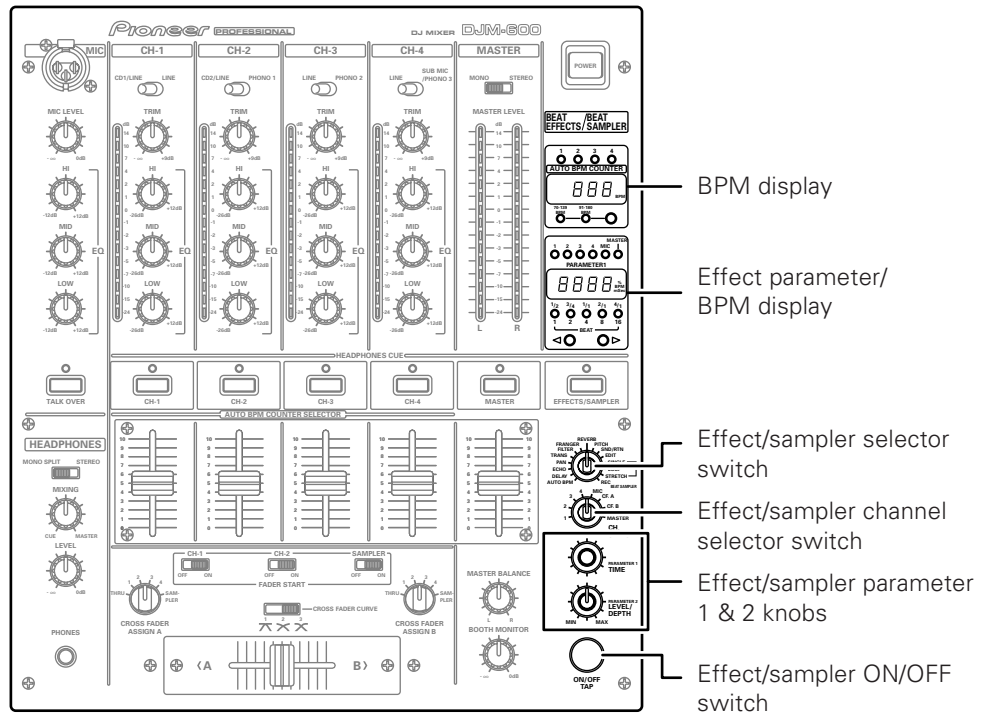

**1 Set the effect/sampler selector switch to SAMPLER REC.**

- The effect/sampler ON/OFF switch will light red.

**2 Set the effect/sampler channel selector switch to 1.**

- LED "1" on the effect parameter/BPM display will light.
- The BPM of the music input to CH-1 will be displayed on the BPM display.
- \* The BPM band that matches the music on CH-1 can be selected with the BPM measurement range selector switch.
- \* LED will blink if BPM cannot be measured for more than 2 seconds. In this case, use manual mode to make settings (see page 15).

**3 Set the recording time.**

- Press the effect beat selector switch and "8" will light on the beat display.
- \* To set the recording time more precisely, use the effect/sampler parameter 1 knob (TIME). The time that was set will be displayed on the effect parameter/BPM display. The maximum recording time is eight seconds.
- \* The effect/sampler parameter 2 knob (LEVEL/DEPTH) will not function.

**4 Set the effect/sampler ON/OFF switch to ON at the time you wish to record.**

- Automatically begins recording when sound signals from a player, etc., have been detected.
- When recording begins, the effect/sampler ON/OFF switch will blink red.
- Recording will automatically terminate when the set number of beats has been recorded.
- Pressing the effect/sampler ON/OFF switch during recording will terminate recording.

**BPM display**

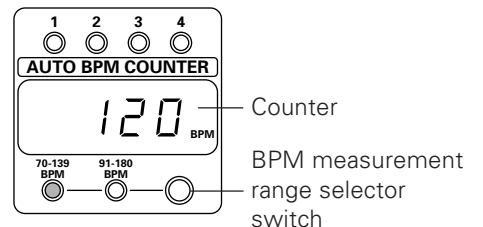

**Effect parameter/BPM display**

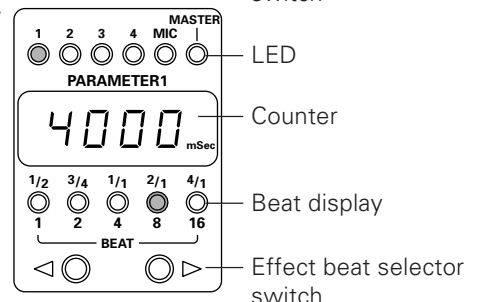

### Using Sampler Playback Functions

Following are the three available methods for playing back the sound recorded with the unit's built-in sampler.

<b>SINGLE PLAY</b>	Plays only while the effect/sampler ON/OFF is being pressed.
<b>LOOP PLAY</b>	Repeatedly plays the recorded sound.
<b>STRETCH LOOP PLAY</b>	Based on the BPM of the music to be mixed, repeatedly plays the sound recorded within the set number of beats (1, 2, 4, 8, or 16). The recorded sound will be played stretched to match the set number of beats.

Example: Mixing stretch loop play of recorded music with music on CH-2 (BPM=130).

**1 Set the effect/sampler selector switch to STRETCH LOOP PLAY.**

- The effect/sampler ON/OFF switch will light green.

**2 Set the effect/sampler channel selector switch to 2.**

- LED "2" on the effect parameter/BPM display will light.
- The BPM of the music input to CH-2 will be displayed on the BPM display's counter.
- \* The BPM band that matches the music on CH-2 can be selected with the BPM measurement range selector switch.
- \* LED will blink if BPM cannot be measured for more than 2 seconds. In this case, use manual mode to make settings (see page 15).

**3 Set the playback time and playback level.**

- Press the effect beat selector switch and "8" will light on the beat display.
- \* To set the playback time more precisely, use the effect/sampler parameter 1 knob (TIME). The time that was set will be displayed on the effect parameter/BPM display.
- \* The playback level is set using the effect/sampler parameter 2 knob (LEVEL/DEPTH).

**4 Set the effect/sampler ON/OFF switch to ON.**

- When playback begins, the effect/sampler ON/OFF switch will blink green.

**BPM display**

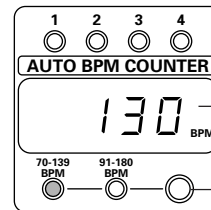

- Counter
- BPM measurement range selector switch

**Effect parameter/BPM display**

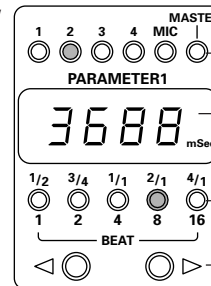

- LED
- Counter
- Beat display
- Effect beat selector switch

### Using Sampler Edit Function

Use the sampler housed inside the unit to set the position where playback of the recorded sound is completed.

**1 Set the effect/sampler selector switch to EDIT.**

- The effect sampler ON/OFF switch will light in green.

**2 Set the effect/sampler ON/OFF switch to ON.**

- When playback begins, the effect/sampler ON/OFF switch will blink green.

**3 Set the playback stop position.**

- While monitoring the loop playback sound, set the playback completion position (loop end point) with the effect/sampler parameter 1 knob (TIME). The time that was set will be displayed on the effect parameter/BPM display.
- \* It is impossible to set it longer than the time that was recorded.

# USING THE FADER START FUNCTION

If the separately sold CDJ-100S, CDJ700S and CDJ-500 II players are connected to CH-1 or CH-2, they can be started using the channel fader volume or cross fader volume control, as long as the control cables have been connected. In addition, the sound recorded with the unit's built-in sampler can also be started using the cross fader volume control.

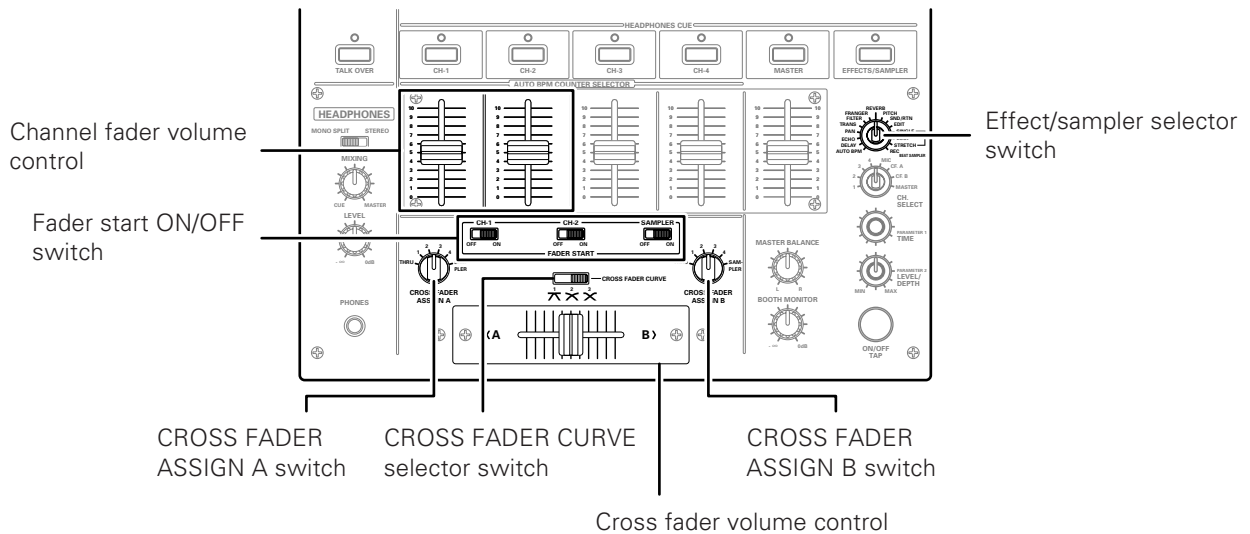

## Fader Start Play (when starting a connected CD player)

Fader start play will be possible when the unit has been connected with control cables to the CDJ-100S, CDJ-700S, and CDJ-500 II CD players for DJs. In other words, when the mixer's channel fader or cross fader volume controls are turned up, the CD player's pause function will be released, and the music will start automatically and instantly. In addition, because the CD player can be restored to the cue point when the fader is returned to its original position, sampler-type play is also possible.

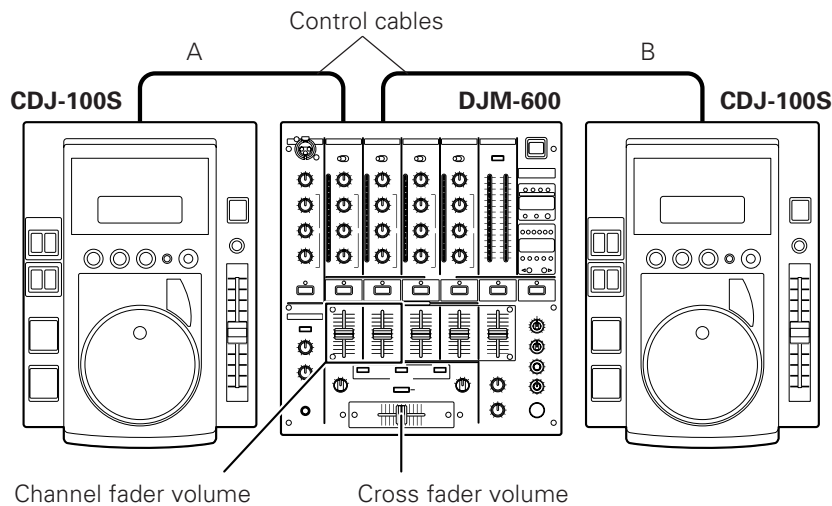

### Cross Fader Start Play and Back Cue Play

When "A" is at the cue point during standby, it can be started simply by moving the cross fader volume control from the right side to the left. "B" will back cue (return to the cue point) at the same time.

Moreover, when "B" is at the cue point during standby, it can be started simply by moving the cross fader volume control from the left side to the right. ("A" will back cue at the same time.)

CD players for which fader start play is possible when connected to this unit

- CDJ-100S**
- CDJ-700S**
- CDJ-500 II**

**Starting with the Channel Fader**

- 1 Turn on the fader start switch (CH-1 or CH-2) of the channel connected to the CD player to be controlled.
- 2 Push the channel fader volume control all the way to the bottom.
- 3 Set the cue point of the CD player and set the player to standby at it.
- 4 When you want to start the player, push up the channel fader volume control and the CD player will begin playing.

**Precaution:**

- Channels selected with the cross fader ASSIGN A and B switches cannot be started with the channel fader.

The following is an example of starting a CD player connected to CH-1.

Example:

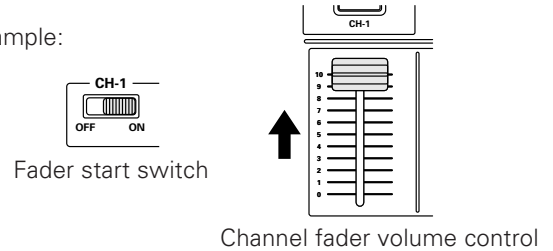

If cue points have been set in advance when using the CDJ-100S and CDJ-700S, it is not necessary to leave the CD player on standby at the cue point. If the channel fader volume is returned to its original position after playing has started, the CD player will return to the cue point and be on standby.

**Starting with the Cross Fader**

- 1 Turn on the fader start switch (CH-1 or CH-2) of the channel connected to the CD player to be controlled or of the sampler.
- 2 Using the cross fader ASSIGN A and B switches, select the channel (CH-1 or CH-2) that the CD player is connected to or the sampler.
- 3 Slide the cross fader volume all the way in direction opposite the source you want to start. In the following example, startup is done with the CD player connected to CH-1 set to ASSIGN A.

Example:

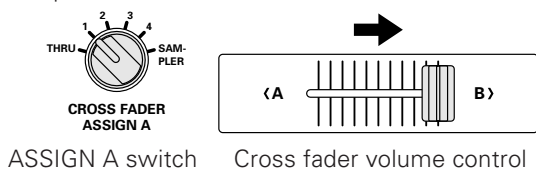

- 5 Use the cross fader curve selector switch to select the cross fader startup curve.
- 6 When the cross fader volume control is slid in the opposite direction as in "3", CD player or sampler play will begin.

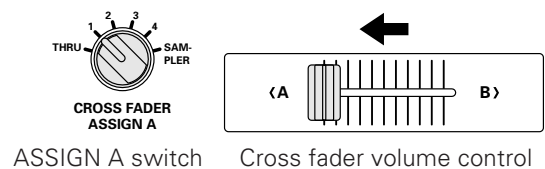

If cue points have been set in advance when using the CDJ-100S and CDJ-700S, it is not necessary to leave the CD player on standby at the cue point. If the cross fader volume is returned to its original position after playing has started, the CD player will return to the cue point and be on standby.

- 4 For starting a CD player, set its cue point and set it to standby at this cue point. For starting a sampler, select the type of sample play (SINGLE, LOOP or STRETCH LOOP) with the effect/sampler selector switch.

When the type of sample play is selected with the effect/sampler selector switch, the effect/sampler ON/OFF switch will light green.

# TROUBLESHOOTING

Incorrect operations are often mistaken for trouble and malfunctions. If you think there is something wrong with this component, check the points below. Sometimes the trouble may originate from another component. Thus, also check the other electrical appliances also in use.

If the trouble cannot be rectified even after checking the following items, contact your dealer or nearest PIONEER service center.

Problem	Possible Cause	Countermeasure
The power does not turn on.	<ul style="list-style-type: none"> <li>● The power cord has not been connected.</li> </ul>	<ul style="list-style-type: none"> <li>● Connect the cord to a power outlet.</li> </ul>
There is little or no sound.	<ul style="list-style-type: none"> <li>● The input selector switch is in the wrong position.</li> <li>● The connection cable hasn't been connected properly or has been disconnected.</li> <li>● The terminal or plug is dirty.</li> <li>● The master output level control (MASTER LEVEL ATT.) on the back has been set too low.</li> </ul>	<ul style="list-style-type: none"> <li>● Set the input selector switch to the device currently playing.</li> <li>● Connect it properly.</li> <li>● Clean and reconnect.</li> <li>● Adjust the master output level control (MASTER LEVEL ATT.) on the back.</li> </ul>
Sound is distorted.	<ul style="list-style-type: none"> <li>● Master output level is too high.</li> <li>● Input level is too high.</li> </ul>	<ul style="list-style-type: none"> <li>● Adjust the master output level control (MASTER LEVEL ATT.) on the back.</li> <li>● Adjust the TRIM knob so that the input level approaches 0dB on the peak level meter.</li> </ul>
Can't use cross fading.	<ul style="list-style-type: none"> <li>● ASSIGN A &amp; B haven't been set correctly.</li> </ul>	<ul style="list-style-type: none"> <li>● Set the ASSIGN switches to the correct cross fader source.</li> </ul>
CD player's fader won't start.	<ul style="list-style-type: none"> <li>● Fader start switch is off.</li> <li>● The player control terminal on the back hasn't been connected.</li> </ul>	<ul style="list-style-type: none"> <li>● Turn on the fader start switch.</li> <li>● Use the control cable to connect the unit and CD player.</li> </ul>
Effects don't work.	<ul style="list-style-type: none"> <li>● Effect/sampler selector switch hasn't been set correctly.</li> <li>● Effect/sampler parameter 2 knob was set to the minimum (MIN.).</li> </ul>	<ul style="list-style-type: none"> <li>● Correctly select the channel to which effects should be applied.</li> <li>● Adjust the effect/sampler parameter 2 knob.</li> </ul>
External effector's sound distorted.	<ul style="list-style-type: none"> <li>● The input level from the external effector is too high.</li> </ul>	<ul style="list-style-type: none"> <li>● Lower the external effector's output level or adjust the return level using the effect/sampler parameter 2 knob.</li> </ul>
Can't measure BPM. Measured BPM values are strange.	<ul style="list-style-type: none"> <li>● Input level is too high or too low.</li> <li>● BPM can't be measured in some cases, depending on the music.</li> </ul>	<ul style="list-style-type: none"> <li>● Adjust the TRIM knob so that the input level approaches 0dB on the peak level meter.</li> <li>● Adjust input levels of other channels to approach 0dB.</li> <li>● Press the TAP switch and set BPM manually.</li> </ul>
Measured BPM value differs from value indicated on CD.	<ul style="list-style-type: none"> <li>● Because of different BPM measurement methods, somewhat different values may be indicated.</li> </ul>	<ul style="list-style-type: none"> <li>● No countermeasures necessary.</li> </ul>
Can't use CH-4's PHONO 3 input terminal.	<ul style="list-style-type: none"> <li>● A sub-microphone has been connected.</li> </ul>	<ul style="list-style-type: none"> <li>● Disconnect the sub- microphone.</li> </ul>

Static electricity or other external interference may cause the unit to malfunction. To restore normal operation, turn the power off and then on again.



# SPECIFICATIONS

## Audio Section

### Input terminal (input level/impedance)

CD/LINE .....	-14dBV (200mV)/22k $\Omega$
PHONO .....	-54dBV (2mV)/47k $\Omega$
MAIN MIC .....	-54dBV (2mV)/3k $\Omega$
SUB MIC .....	-60dBV (1mV)/3k $\Omega$
RETURN .....	-14dBV (200mV)/22k $\Omega$

### Output terminal (output level/impedance)

MASTER OUT1 (RCA) .....	0dBV (1V)/1k $\Omega$
MASTER OUT2 (XLR) .....	4dBm (1.23V)/600 $\Omega$
REC OUT (RCA) .....	-10dBV (1V)/1k $\Omega$
BOOTH MONITOR .....	0dBV (1V)/1k $\Omega$
SEND .....	-14dBV (1V)/1k $\Omega$
PHONES .....	0dBV (1V)/22 $\Omega$

### Frequency characteristics

CD/LINE/PHONO/MIC .....	20Hz to 20kHz
-------------------------	---------------

### SN ratio

CD/LINE .....	87dB (with effects off)
PHONO .....	77dB
MIC .....	69dB

### Total harmonic distortion rate

CD/LINE/PHONO .....	Below 0.02%
---------------------	-------------

Cross talk ..... Over 70dB

### Channel equalizer

HI .....	+12dB, -26dB (13kHz)
MID .....	+12dB, -26dB (1kHz)
LOW .....	+12dB, -26dB (70Hz)

### Microphone equalizer

HI .....	+12dB, -12dB (10kHz)
MID .....	+12dB, -12dB (1kHz)
LOW .....	+12dB, -12dB (100Hz)

### Effector

DELAY and ECHO .....	1 to 3500mSec
PAN, TRANS, FILTER and FLANGER .....	10 to 16000mSec
REVERB .....	1 to 100%
PITCH .....	0 to $\pm$ 100%

## Electrical Section, etc.

Power supply voltage .....	AC 120V, 60Hz
Power consumption .....	36W
Operating temperature .....	+5°C to +35°C
Operating humidity .....	5% to 85%
External dimensions .....	320 (W) x 372 (D) x 107 (H) mm 12-19/32 (W) x 14-5/8 (D) x 4-7/32 (H) in
Weight .....	6.6kg 14lbs 9oz

## Accessories

● Short-circuit pin plug .....	6
● Operating instructions .....	1
● Warranty .....	1

For improvement purposes, specifications and design may be subject to modification without notice.





Published by Pioneer Corporation.  
Copyright © 1999 Pioneer Corporation.  
All rights reserved.

---

**PIONEER CORPORATION** 4-1, Meguro 1-Chome, Meguro-ku, Tokyo 153-8654, Japan

**PIONEER NEW MEDIA TECHNOLOGIES, INC.**

**Multimedia and Mass Storage Division:** 2265 East 220th Street, Long Beach, CA 90810, U.S.A. TEL: 800-444-OPTI (6784)

**PIONEER ELECTRONICS OF CANADA, INC.**

**Industrial Products Department:** 300 Allstate Parkway, Markham, Ontario L3R 0P2, Canada TEL: 905-479-4411